

CABINETS JOINERY COMPONENTS

Affordable Quality Cabinetry Solutions!





Amorini's quality joinery components are the easy choice for your kitchens.

For over 40 years we've been manufacturing the highest quality cabinet componentry right here in New Zealand.

Our new trade range is extensive and comes with numerous décor options, all delivered in superfast lead times that will delight you and your customers.

Affordable Quality Cabinetry Solutions



**ANTI
FINGERPRINT**

**NOIR
ZENIT PLUS**

the
**DIAMOND
COLLECTION**

-  Melamine Faced MDF (E0 Carcass)
-  18mm MDF Fronts
-  Solid Back Construction
-  European Hardware – Lifetime Warranty
-  Quick Ship – Ex Stock
-  Pre-Drilled – Easy Assembly
-  Extensive Range & Combinations
-  Variable Cabinets For Customised Design
-  Order Online 24/7
-  10 Year Ltd Warranty – Cabinets

DESIGN YOUR KITCHEN WITH OUR VERSATILE CABINET RANGE!

BASE AND WALL CABINET SAMPLE SIZES

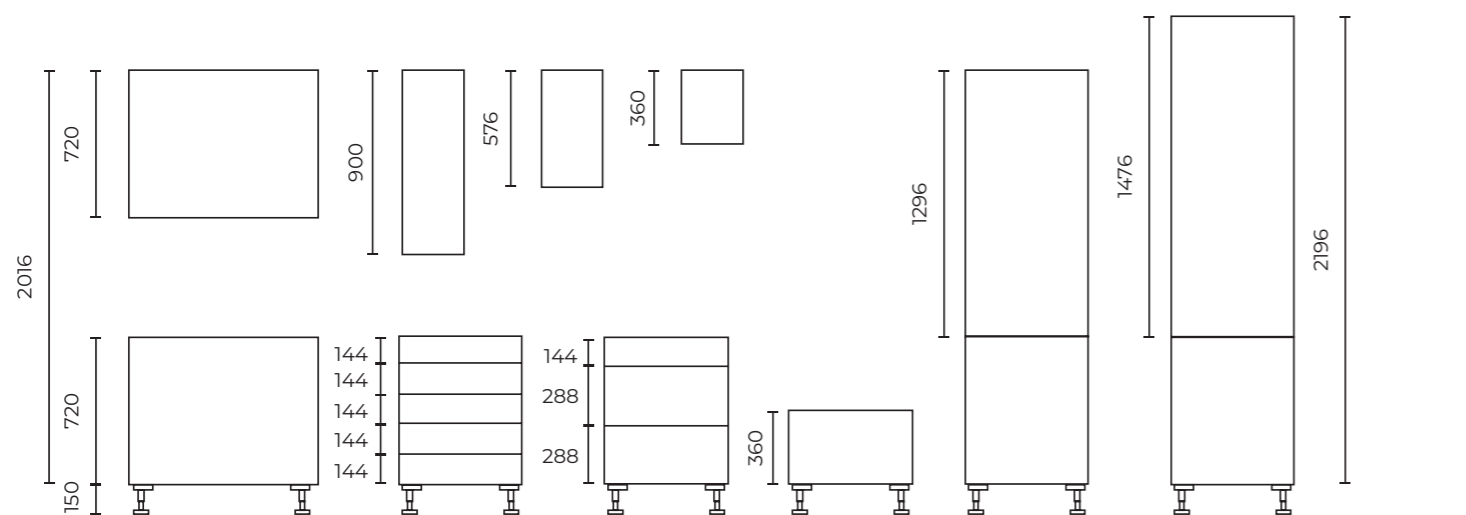

PANTRY COMBO UNIT EXAMPLE

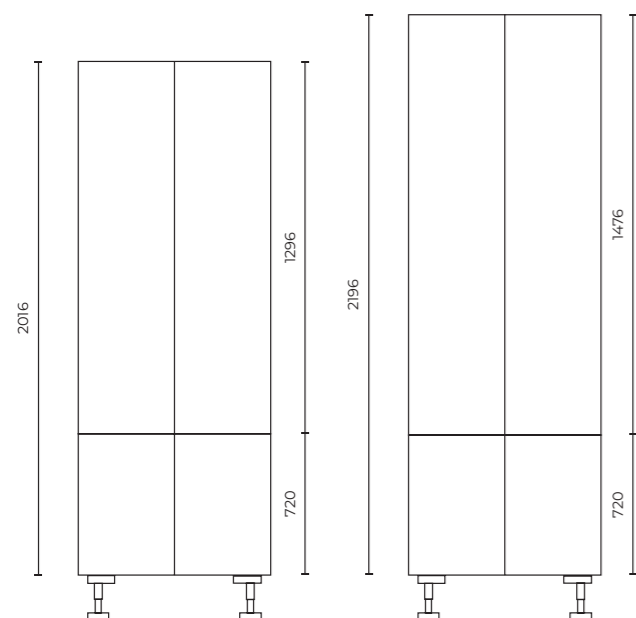

PULL OUT UNIT EXAMPLE

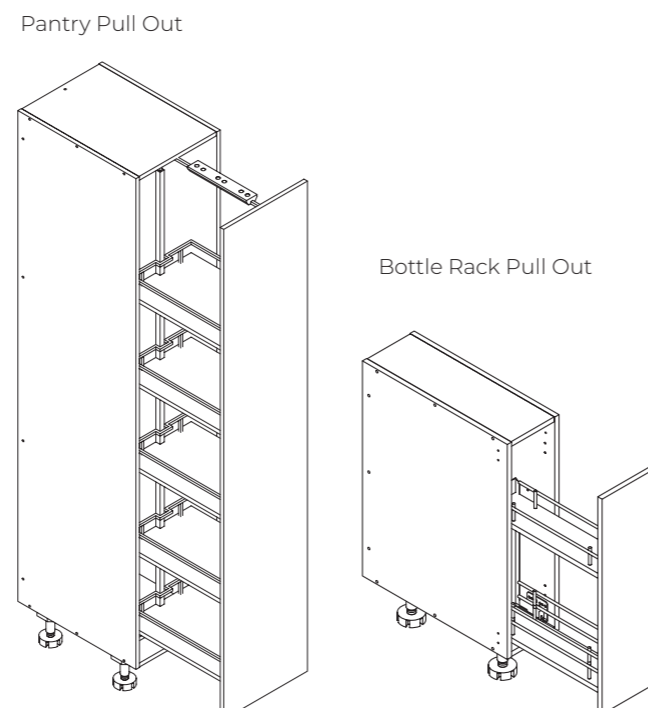

VARIABLE CABINETS TO CUSTOMISE YOUR DESIGN

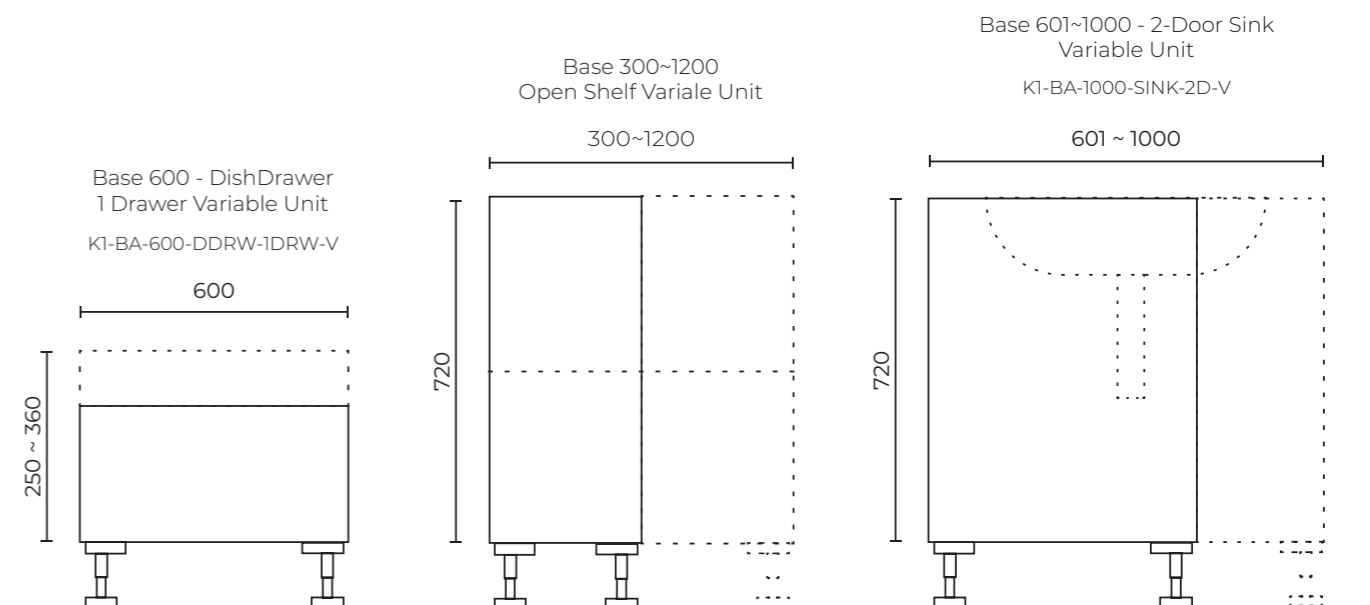
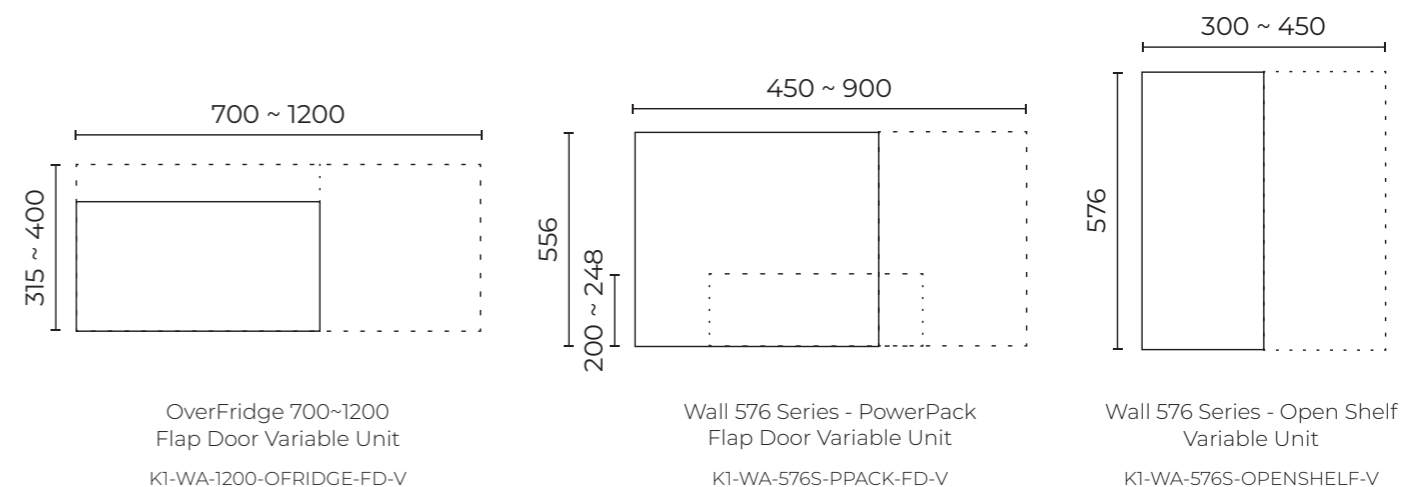

Blind Corner Unit (Reversible)
Corner return design flexibility
from 50-150mm each-way
KI-BA-900-BLIND-CNR

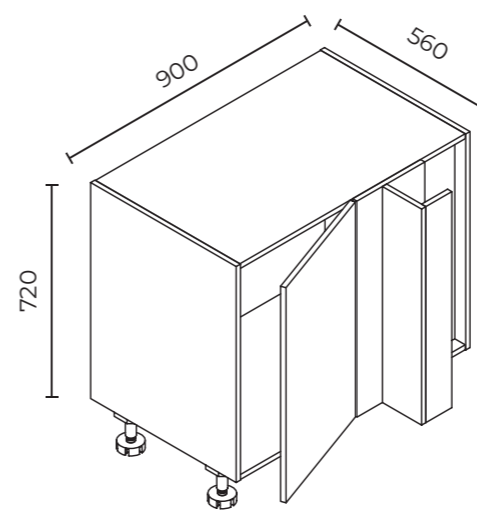

Tower Oven Unit example
with variable oven space

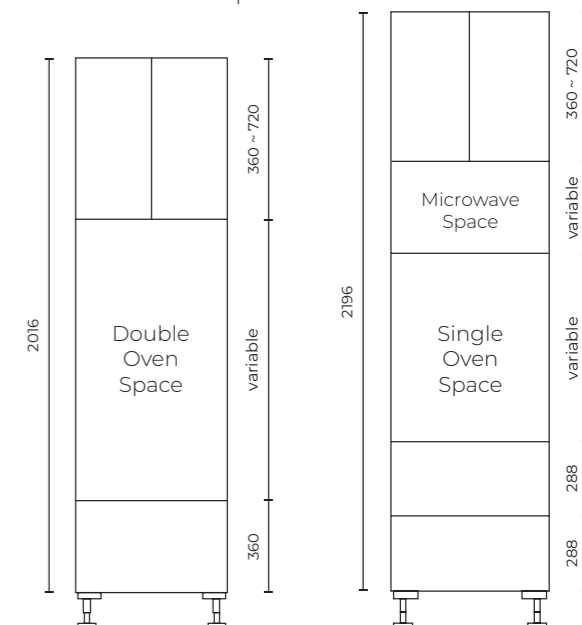

Melamine Décor Options

Choose from our stock melamine décor options or combine with your own. Designer décors are available with a **5 working day dispatch**. Designer Plus décors incur additional lead time.



DESIGNER RANGE



AGED ASH
Melteca

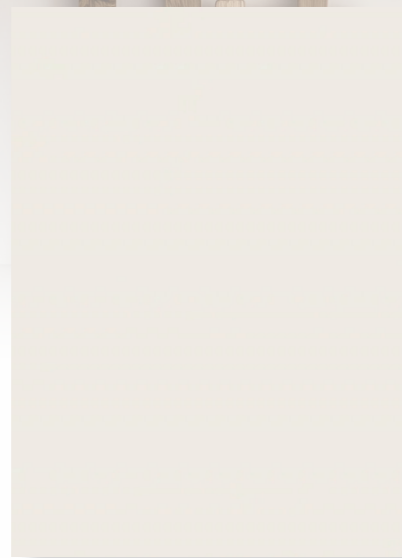

BAIKAL
Melteca

Designer Range Collection!

Additional range of Designer Plus Melamine Décors also available. Visit amorini.co.nz



Thermoform Décor Options

Thermoform doors and drawers offer high-quality, seamless edges and a durable surface finish that resists chipping and scratching. Select from a variety of popular profiles and décors to enhance your design, with matching melamine décor available and a **15 working day dispatch time**.

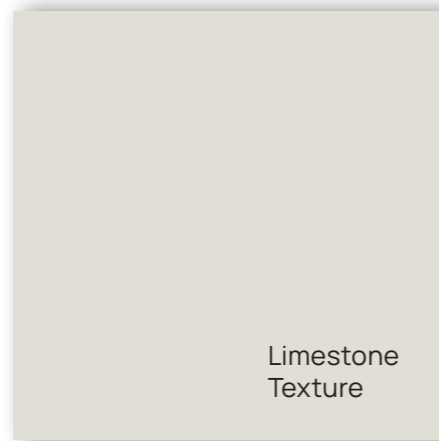
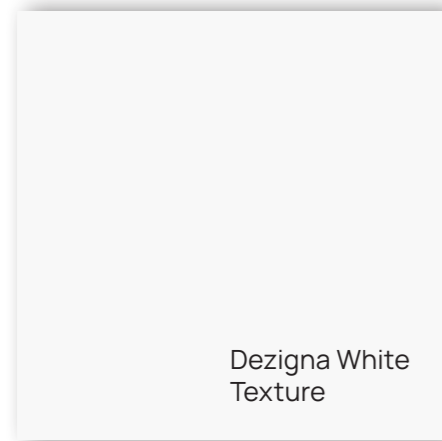

Thermoform Profile Options

Milan
Edge Profile R3



Ronda
Shaker Style



Please note: To ensure exact matching colour and texture to end panels, to match the colour of the door designs, it is essential to order your panels as Thermo-Formed Panels.

Some Thermo-Formed colours are available with a Matching Melamine Panel. This allows for a substantial cost saving however very important to know the colour is not a 100% match and the surface is a different texture as Melamine is a different product to the Vinyl.

Therefore will always show as a different colour to the naked eye.



Thermoform Profile Options

Thermoform doors and drawers feature a range of designs, including more intricate shapes that satisfy a need for design differentiation.



Russell

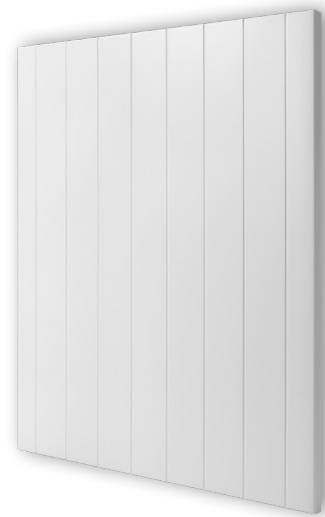

Lyon



Berlin



Calais



Munich

Melteca surfaces offer you the perfect solution for creating exceptional interior spaces.

Laminex
NEW ZEALAND

Inspired by international trends and local lifestyles so you can trust that our highly durable, low maintenance and easy to clean range of decorative panels are the ideal choice.



MELTECA®



the
**DIAMOND
COLLECTION**

Powered by  Amorini

the Diamond Range

Lacquered surfaces that feature two-faced panels with a variety of unique finishes, from Anti-Fingerprint to Mirror Gloss. Now available from Amorini to enhance your designs and customer solutions. Available with a 10 working day dispatch.

the Diamond Range

Crafted from premium MDF, panels undergo a meticulous manufacturing process that involves multiple layers of lacquer cured by Ultra-Violet drying, ensuring exceptional durability and quality. Available with a 10 working day dispatch.



Noir embodies power, strength and elegance, making it a compelling choice in an anti-fingerprint finish for cabinetry design.



Gris Nube – supermatt, is a serene and neutral shade that strikes a perfect balance between light and dark grey, embodying practicality and elegance while promoting a sense of wellbeing.

Whereas, Antracita, a deep shade in the grey palette with an anti-fingerprint, providing a neutral backdrop that seamlessly complements wood elements and light monochromatic designs.



ANTRACITA
cosmopolitan and versatile

Blanco Polar Zenit – supermatt, boost any interior design project, creating spacious environments that can be combined with any other design.



BLANCO POLAR ZENIT
an always on-trend classic

Zenit[®]
PLUS
by  Amorini
the **DIAMOND COLLECTION**

Zenit[®]
by  Amorini
the **DIAMOND COLLECTION**

the Diamond Range

Available with a 10 working day dispatch.

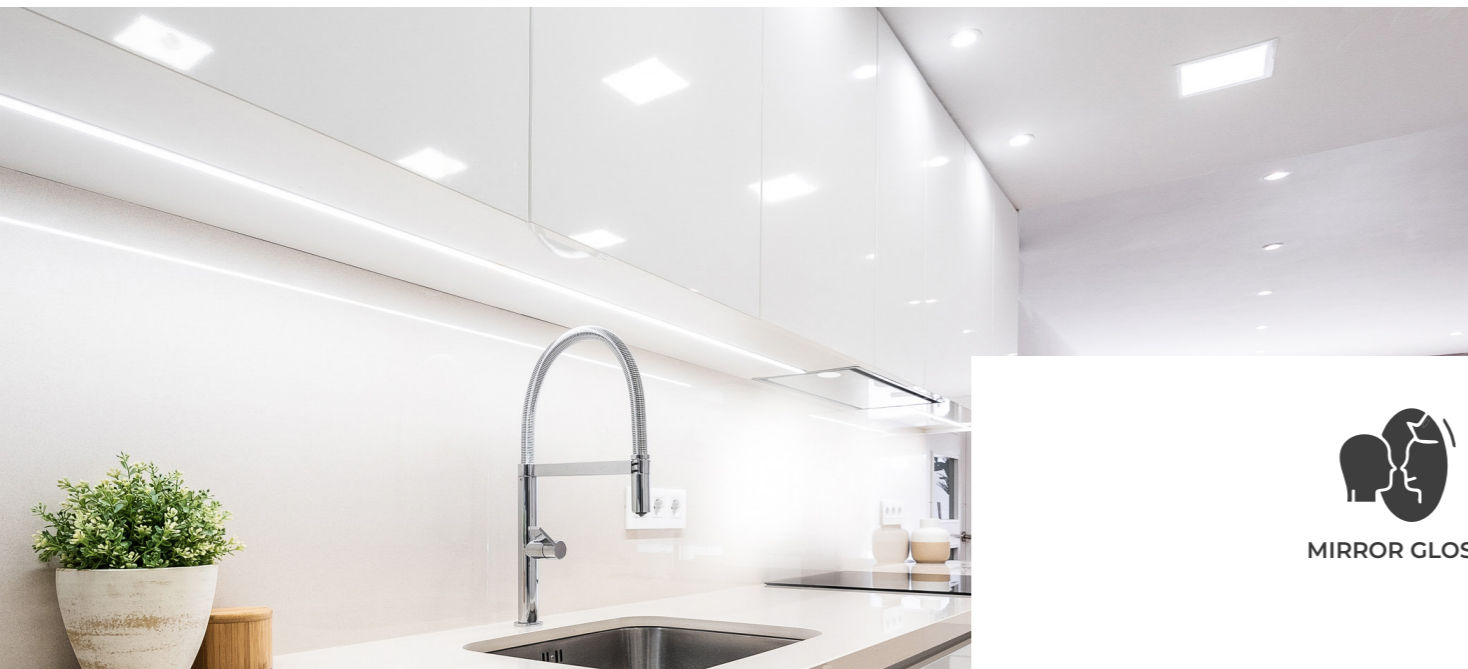

Blanco Polar Luxe – a colour of light that creates spacious environments and can be combined with any design. Its' mirror gloss finish provides a vibrant interior.



MIRROR GLOSS

BLANCO POLAR LUXE

the king of brightness

Discover the properties of the new generation 3.0 of Diamond Collection –



Highly scratch resistant



High abrasion resistance



Two-faced décor panel



Easy cleaning



100% environmentally friendly lacquer



Long durability

SUPPLYING SUSTAINABLE SURFACES



the **DIAMOND COLLECTION**



Our New Zealand Panels Group Melamine faced MDF MR/EO cabinetry board is made right here in New Zealand and carries – Environmental Choice NZ accreditation.

PrimePanels^{NZ} BESTWOOD®



Powered by Amorini

With a 50-year pedigree, SIGE S.p.a. is a premium Italian manufacturer of intelligent pantry storage and waste management solutions.

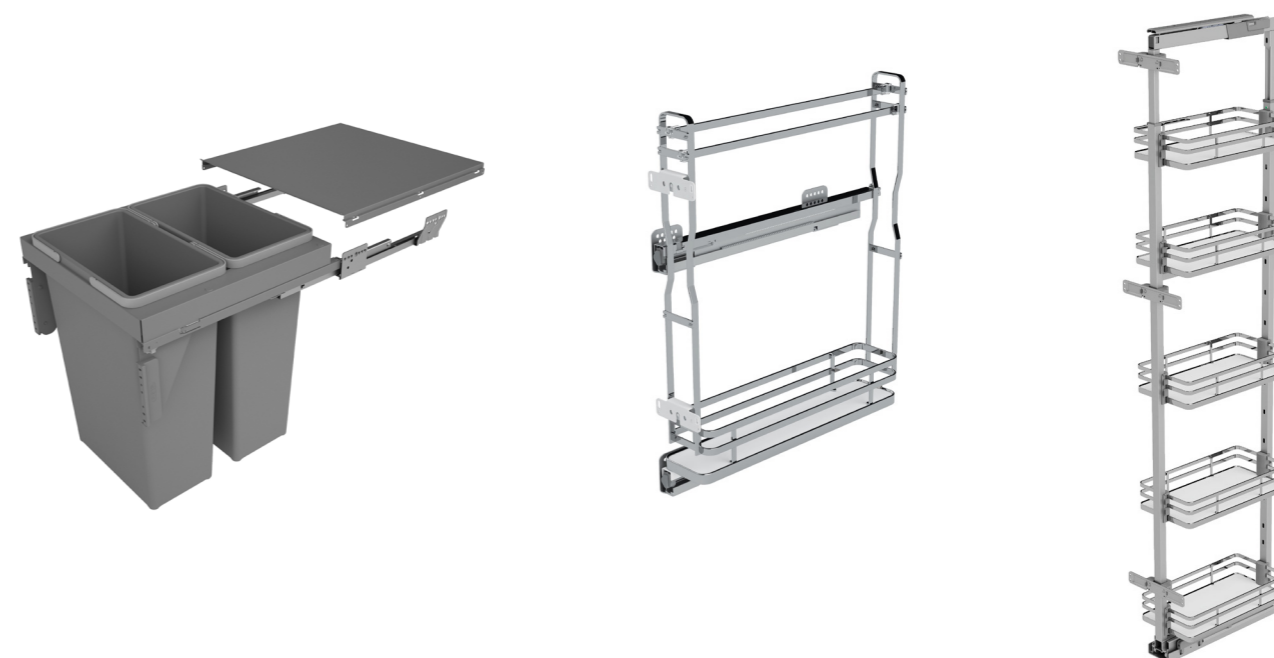

Grass Movement

Nova Pro / Scala drawers feature a luxury, smooth-running opening and closing action with the latest in soft closing technology.

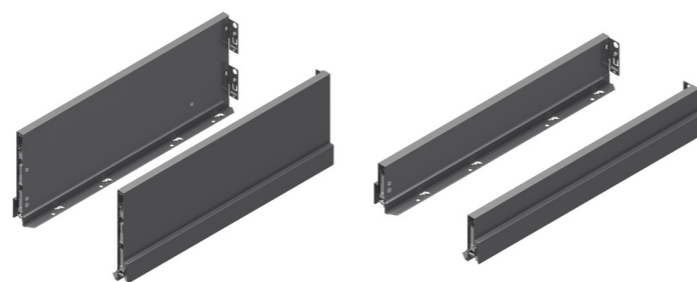

Tiomos Hinge system - One of the outstanding characteristics of the hinge system is the soft-close damper, which features stepwise adjustment and is fully concealed within the hinge arm.

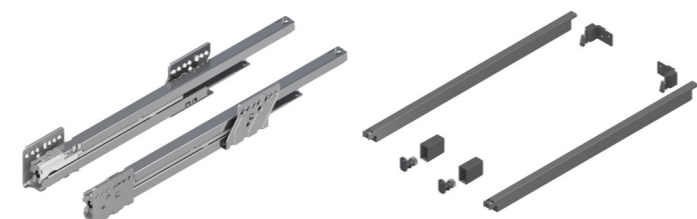

The complex inner workings of this high-tech hinge are hidden from view, much like a Swiss clock movement, and are sure to impress with their unique damping characteristics.

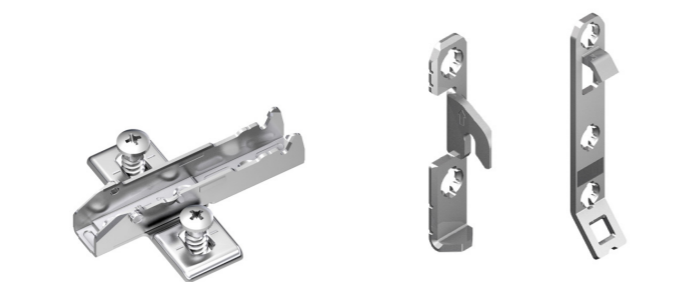

Grass hardware comes with 25 years of warranty.



Powered by Amorini

GRASS®



5 - DAY Dispatch

24/7 Ordering

Our centrally located DC center in Palmerston North means we can dispatch cabinetry & stocked décor orders in only 5 days and ship New Zealand wide.

Order your joinery components anytime with our convenient 24/7 online ordering portal.

To **register** visit estore.amorini.co.nz or email us at info@amorini.co.nz

Talk to Amorini now, for affordable, quality, **MDF kitchen cabinetry solutions** to support your business.

With an extensive range of cabinetry components, incorporating European hardware, 24/7 ordering capability, available **New Zealand wide with a 5-day dispatch time!**

WHAT ARE YOU WAITING FOR?

REGISTER NOW!



24/7
ONLINE ORDER



EXTENSIVE
RANGE



5 DAY
DISPATCH



ECO-FRIENDLY



SUSTAINABILITY



MADE IN
NEW ZEALAND

NKBA
National Kitchen & Bathroom Association - NZ

Our offer is extensive and exclusively for our wholesale & trade customers.

Powered by

 Amorini



Scan here or visit





amorini.co.nz

Copyright © 2024 Amorini – Version 4.0 – March 2025

Follow us:

 @AmoriniNZ

 @Amorini_nz

 @AmoriniNZLtd

 @Amorini NZ

PO BOX 5390,
Palmerston North, New Zealand.
(06) 358 2759 | info@amorini.co.nz